

# Data Sheet



Article number: 12511600025500

Description: KLEE-coil 511 600 025.500  
M2,5 Stainless 1.4305

## Measures

---

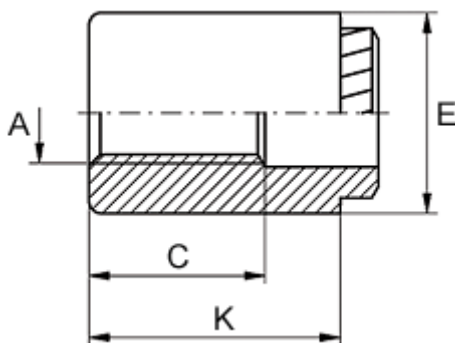

Female thread A	= M2,5
Height K	= 11
Hole diameter +0.1	= 4.2
Min distance to edge	= 2.4
Min material thickness	= 1.5
Outer diameter E	= 6
Thread length	= 9